

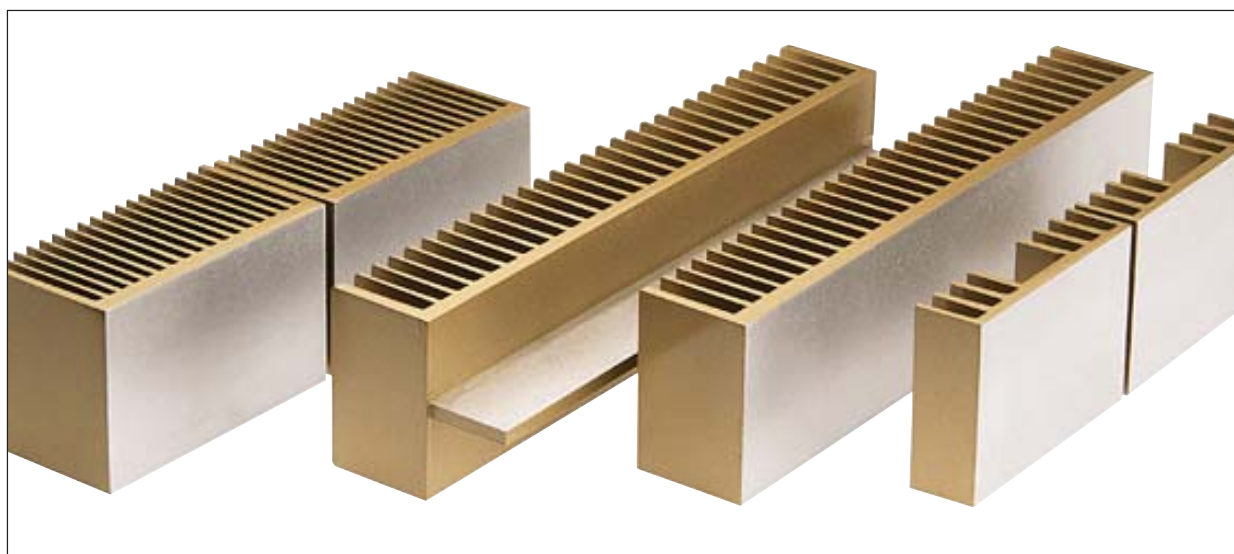

# CONRAD HEATSINKS

## *2005 Catalogue*



Conrad Heatsinks  
36 Victoria Street  
Brunswick East, 3057  
Melbourne, Victoria  
Australia

Phone: 61-3-9387 7106  
Fax: 61-3-9387 2896  
sales@conradheatsinks.com  
www.conradheatsinks.com



# Conrad Heatsinks.

Conrad Engineering is a designer and manufacturer of heatsinks for the use in electrical and electronic applications.

Since its inception in 1982, the Conrad heatsink range continues to offer designs that combine superior thermal properties, unique features, premium quality and excellent value.

<i>Contents</i>	<b>Page</b>
<i>Product Types</i>	3
<i>Technical Specifications</i>	4
<b>Flat Backed Heatsinks - Standard Fin Spacing</b>	
MF 10 Series	7
MF 12 Series	7
MF 15 Series	8
MF 20 Series	8
MF 25 Series	9
MF 30 Series	9
MF 35 Series	10
<b>Flat Backed Heatsinks - Fine Fin Spacing</b>	
MF 18 Series	10
<b>Single Flanged Heatsinks</b>	
MF 15-1F-75	11
MF 20-1F-75	11
MF 30-1F-75	12
<b>Double Flanged Heatsinks</b>	
MF 15-2F-151.5	12
MF 20-2F-151.5	13
MF 30-2F-151.5	13
<b>Single Channel Flat Backed Heatsinks</b>	
8 FT Series	14
<i>Price List</i>	15
<i>Order Form</i>	16

# Product Types

**Flat Backed Heatsinks**  
**Standard Fin Spacing (SFS)**  
 MF 10-35 Series  
 Width range 100 to 350 mm



**Flat Backed Heatsinks**  
**Fine Fin Spacing (FFS)**  
 MF 18 Series  
 Width 125 mm

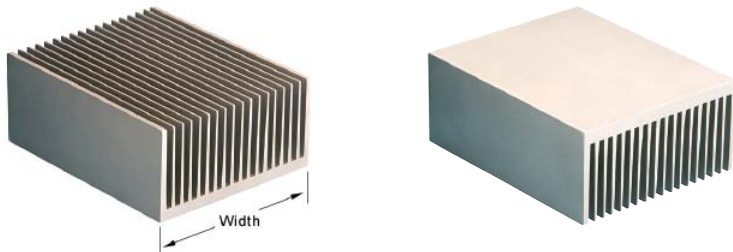

**Single Flanged Heatsinks**  
 MF 15-30 1F Series  
 Width range 150 to 300 mm

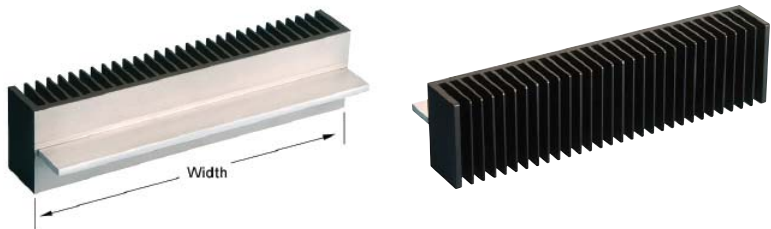

**Double Flanged Heatsinks**  
 MF 15-30 2F Series  
 Width range 150 to 300 mm



**Single Channel Flat Backed Heatsinks**  
 8FT Series  
 Width 111 mm



# Technical Aspects

- Component Mounting Surfaces
- Component Mounting Flange
- Heatsink Proportions
- Section Profiles
- Material Specifications
- Test Conditions
- Thermal Performance and Temperature Rise Above Ambient
- Dimensional Tolerances
- Handling Conrad Heatsinks



## Component Mounting Surface

The component mounting surfaces on Conrad heatsinks are machined, generally lished and remain uncoated. This surface preparation maximizes thermal conductivity between component and heatsink by:

- Removing the relatively thick, thermally insulating surface oxide layer, formed as a result of any hot forming process with aluminium products.
- Providing a flat, smooth surface ensuring maximum surface area contact between component and heatsink.
- Keeping the junction between component and heatsink free of any thermally insulating coating.

## Component Mounting Flange

The flanged mounting feature, as seen on type MF30-1F-75 for example, is designed to improve thermal conductivity, provide greater ease of assembly and savings in cost compared to a fabricated heatsink and right angle bracket arrangement. By eliminating the thermal junction between heatsink base and bracket with a single piece heatsink, component temperatures are significantly reduced. (See diagrams below)

For example, the thermal resistance of the interface between a right angle bracket with cross-section 40x40x6mm bolted at 50mm. intervals to a flat backed heatsink (including thermal grease), has been measured at 3.5 C/W/cm<sup>2</sup>. The corresponding figure for Conrad flanged heatsink is virtually zero.

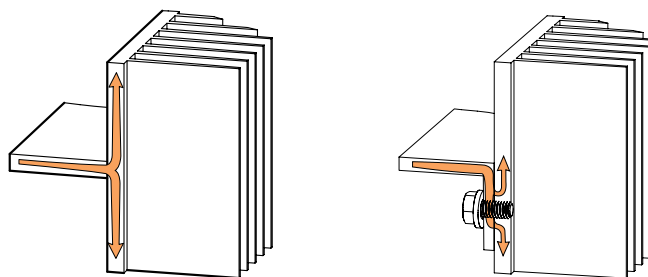

## Heatsink Proportions

As a guide, thermal performance for heatsinks used with natural convection varies:

- in direct proportion to the width (double the width, double the heat dissipation);
- in proportion to the square root of the length (double the length, 40-50% increased heat dissipation).

As a result, width is thermally more effective than length. Comparing two heatsinks of similar thermal performance as shown below, the wider heatsink on the right (MF30-50) gives 45% more effective power dissipation per unit volume and weighs 28% less than the heatsink on the left (MF15-151.5). Hence, the inclusion of relatively broad heatsinks into the Conrad range.

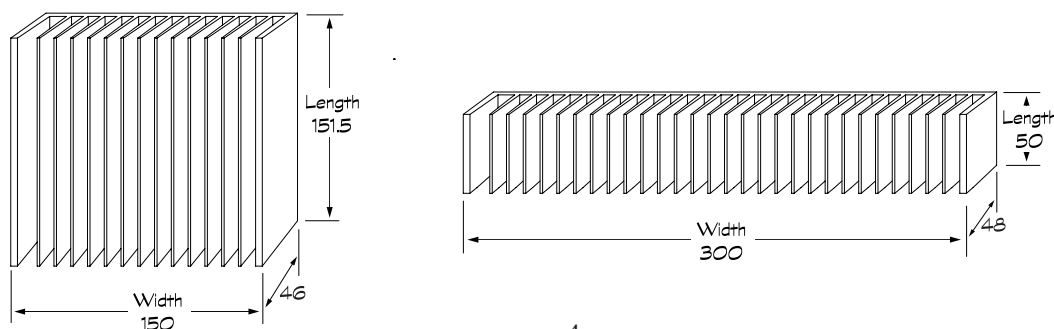



### Section Profiles

The heatsink section profiles have been designed to provide an optimum fin profile for a given fin height, length and convection condition. Except for type MF18, Conrad heatsinks are suitable for both natural convection (where plain plate fins have been found to be the most effective) and forced airflow.

Adequate section thicknesses are provided to maintain conservative temperature gradients across all heatsink surfaces and ensure ample mechanical strength which is necessary for mounting components (in order to maintain flatness and provide sufficient fastener thread depth) and for applications where the heatsink is used as a structural component (for example, as part of an enclosure).

### Material Specifications

Conrad heatsinks are manufactured using primary specification CC 601 aluminium alloy, chosen for:

- high thermal conductivity,
- premium physical properties- strength, ductility, machinability, corrosion resistance and suitability to the forming process.

To maintain premium material properties, all alloy is strontium modified, titanium-boron grain refined and hydrogen de-gassed prior to use in manufacture.

### Coating Material

Textured black polyester powder coating has been chosen as the standard finish on all coated Conrad heatsinks and provides:

- a quality, durable and attractive finish capable of withstanding elevated temperatures,
- increased thermal dissipation in the order of 5% to 8% (depending on the heatsink) under natural convection

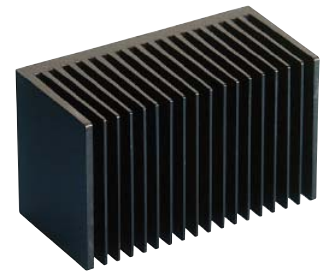

### Test Conditions

The test conditions for Conrad heatsinks apply to a free standing heatsink in still air with the power applied by a distributed heat source, except where otherwise stated. For type MF18, figures for both natural convection and forced air flow are also given using a distributed heat source.

### Thermal Performance and Temperature Rise Above Ambient

Especially for cooling with natural convection, the hotter a heatsink becomes, the more effectively it dissipates heat. The thermal resistance of a heatsink decreases with an increase in the heatsinks temperature rise above ambient.

As a guide to the thermal resistance of a heatsink at a temperature rise T °C above ambient:

$$R(T)=K(T) \times R(80 \text{ }^\circ\text{C}) \text{ (1)}$$

Where R(T) is the heatsink thermal resistance at T°C above ambient, R(80°C) is the heatsink thermal resistance at 80°C above ambient, K(T) is a temperature correction factor read from the graph below corresponding to the temperature rise of T°C

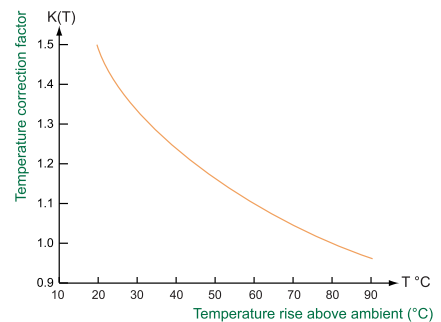

Please note that the thermal performance at different temperature rises, varies from heatsink to heatsink and that the correction factor K is useful as an approximate guide only.

As an example, to estimate the power dissipation using a MF30-75 at a temperature rise of 30°C above ambient:

From the heatsink data, MF30-75 thermal resistance at 80°C rise

$$R(80^\circ\text{C}) = 0.37 \text{ C/W}$$

Reading from the graph above, the temperature correction factor at 30°C

$$K(30^\circ\text{C}) = 1.33$$

Using equation 1, the approximate thermal resistance will be

$$R(30^\circ\text{C}) = 1.33 \times 0.37 \text{ C/W} = 0.492 \text{ C/W}$$

and the approximate power dissipation at 30°C rise above ambient will be

$$P(30^\circ\text{C}) = 30.0/0.492 = 61.18 \text{ Watts}$$

### ***Dimensional Tolerances***

For the heatsink dimensions shown in the following diagrams, tolerances are given in the table below.

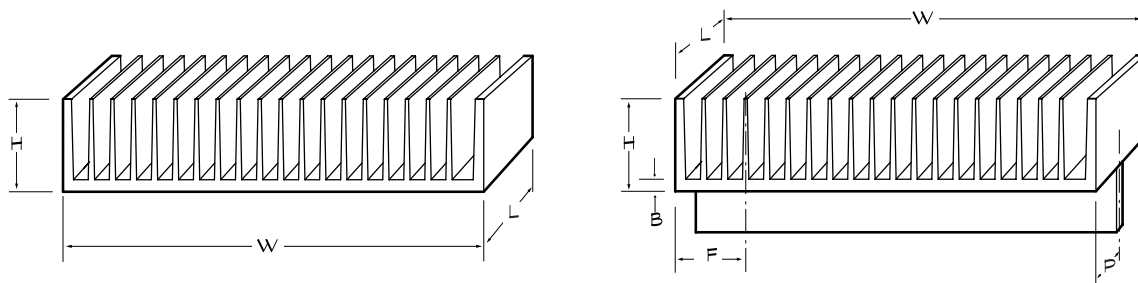

<b>Dimension</b>	<b>Symbol</b>	<b>Tolerance(mm.)</b>	<b>Typically (mm.)</b>
<b>Width</b>	<b>W</b>	+0.5 -0.75	+0.0 -0.5
<b>Height</b>	<b>H</b>	+0.5 -0.0	+0.5 +0.2
<b>Base Thickness (Flat Back Heatsinks)</b>	<b>B</b>	+1.0 -0.0	+0.5 +0.2
<b>Base Thickness (Flanged Heatsinks)</b>	<b>B</b>	+0.75 -0.0	+0.5 -0.0
<b>Fin Position</b>	<b>F</b>	+1.0 -1.0	+0.5 -0.5
<b>Flange Position</b>	<b>P</b>	+1.0 -1.0	+0.5 -0.5
<b>Length</b>	<b>L</b>	+0.25 -0.25	+0.25 -0.25

### ***Handling Conrad Heatsinks***

To obtain the best results when handling and machining aluminium products in general and Conrad heatsinks in particular, we would suggest:

- when holding securely, place on or clamp between clean compliant surfaces (cloth, cardboard etc.) to avoid abrasion and indentation of machined and coated surfaces.
- when machining (drilling, tapping, milling etc.) using cutting fluid and regularly removing, cleaning and re-lubricating the cutting tool. An accumulation of swarf, particularly while drilling and tapping, may cause clogging and result in damage to both the tool and the component

### ***Technical Enquiries***

For further technical information, please contact Conrad Heatsinks.

## *MF10 Series*

All dimensions are in mm.

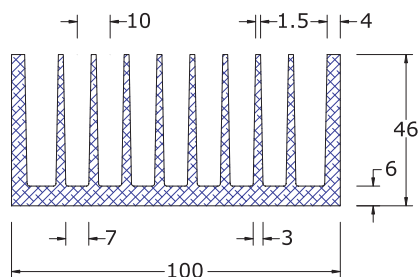

Product Code	Standard Lengths in mm	Thermal Resistance C/Watt for 80 C rise	Weight in kg.
MF10-50	50.0	1.28	0.22
MF10-75	75.0	1.04	0.33
MF10-100	100.0	0.83	0.44
MF10-151.5	151.5	0.61	0.67

## *MF12 Series*

All dimensions are in mm

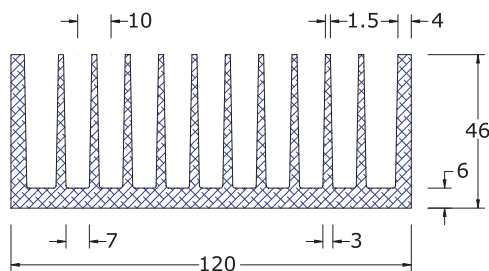

Product Code	Standard Lengths in mm	Thermal Resistance C/Watt for 80 C rise	Weight in kg.
MF12-50	50.0	1.12	0.26
MF12-75	75.0	0.92	0.39
MF12-100	100.0	0.78	0.52
MF12-151.5	151.5	0.57	0.79

## MF15 Series

All dimensions are in mm

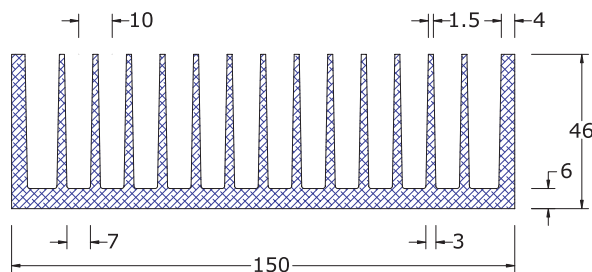

Product Code	Standard Lengths in mm	Thermal Resistance C/Watt for 80 C rise	Weight in kg.
MF15-50	50.0	0.89	0.32
MF15-75	75.0	0.72	0.48
MF15-100	100.0	0.61	0.64
MF15-151.5	151.5	0.50	0.97

## MF20 Series

All dimensions are in mm.

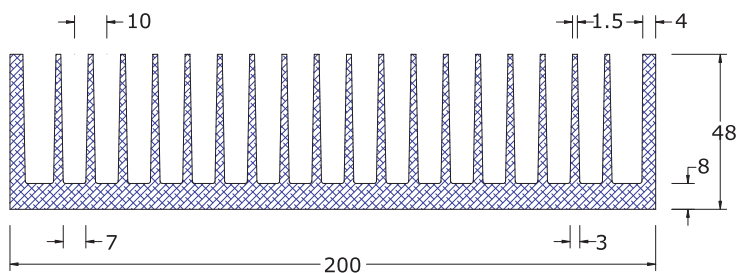

Product Code	Standard Lengths in mm	Thermal Resistance C/Watt for 80 C rise	Weight in kg.
MF20-50	50.0	0.72	0.47
MF20-75	75.0	0.55	0.71
MF20-100	100.0	0.47	0.95
MF20-151.5	151.5	0.36	1.44



## MF25 Series

All dimensions are in mm.

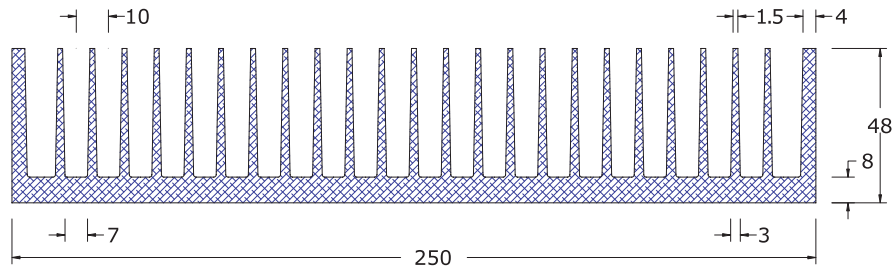

Product Code	Standard Lengths in mm	Thermal Resistance C/Watt for 80 C rise	Weight in kg.
MF25-50	50.0	.060	0.59
MF25-75	75.0	0.45	0.88
MF25-100	100.0	0.37	1.17
MF25-151.5	151.5	0.29	1.78

## MF30 Series

All dimensions are in mm.

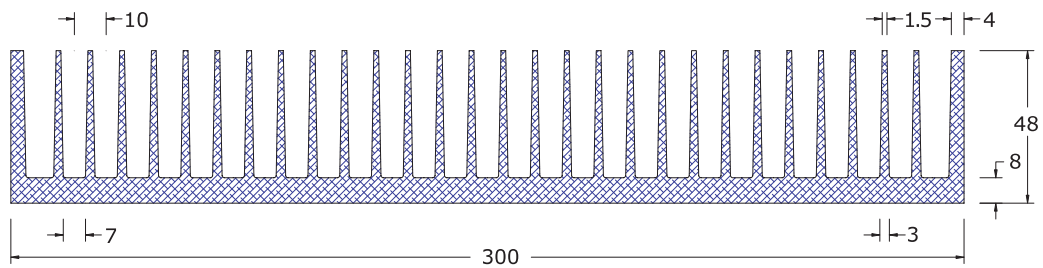

Product Code	Standard Lengths in mm	Thermal Resistance C/Watt for 80 C rise	Weight in kg.
MF30-50	50.0	.049	0.70
MF30-75	75.0	0.37	1.05
MF30-100	100.0	0.32	1.40
MF30-151.5	151.5	0.25	2.12

## MF35 Series

All dimensions are in mm.

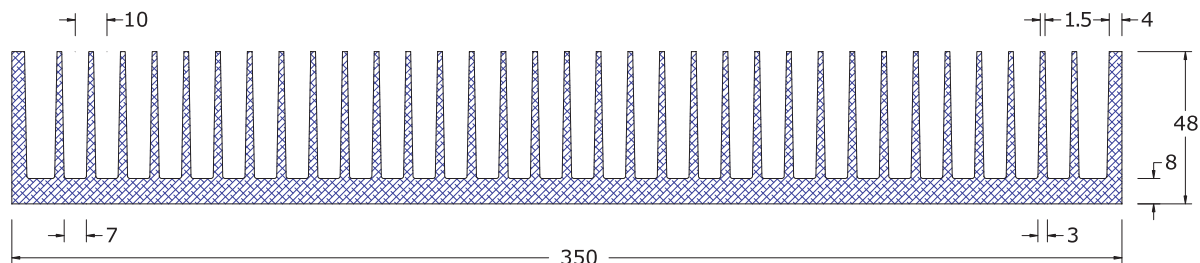

Product Code	Standard Lengths in mm	Thermal Resistance C/Watt for 80 C rise.	Weight in kg.
MF35-50	50.0	0.43	0.81
MF35-75	75.0	0.32	1.22
MF35-100	100.0	0.28	1.62
MF35-151.5	151.5	0.21	2.46

## MF18 Series

All dimensions are in mm

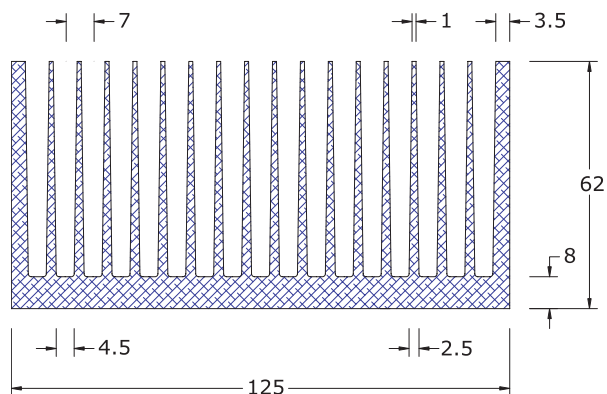

Product Code	Standard Lengths in mm	Thermal Resistance Natural Convection C/Watt for 80 C rise	Thermal Resistance Forced Convection 6.4 l/s (13.5 cfm) C/W	Thermal Resistance Forced Convection 12.7 l/s (27 cfm) C/W	Weight in kg.
MF18-50	50.0	0.84	0.24	0.19	0.41
MF18-75	75.0	0.67	0.20	0.17	0.61
MF18-100	100.0	0.59	0.18	0.15	0.82
MF18-151.5	151.5	0.46	0.13	0.11	1.24

## *MF15-1F-75*

All dimensions are in mm

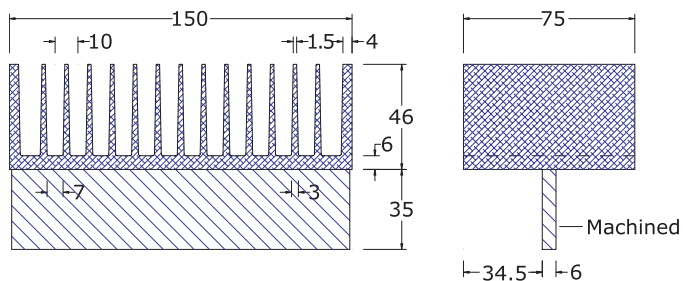

Product Code	Standard Lengths in mm	Thermal Resistance C/Watt for 80 C rise	Weight in kg.
MF15-1F-75	75.0	0.78	0.57

## *MF20-1F-75*

All dimensions are in mm

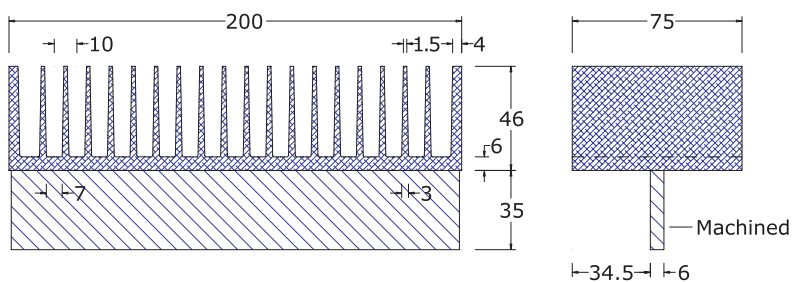

Product Code	Standard Lengths in mm	Thermal Resistance C/Watt for 80 C rise	Weight in kg.
MF20-1F-75	75.0	0.60	0.75

## ***MF30-1F-75***

All dimensions are in mm

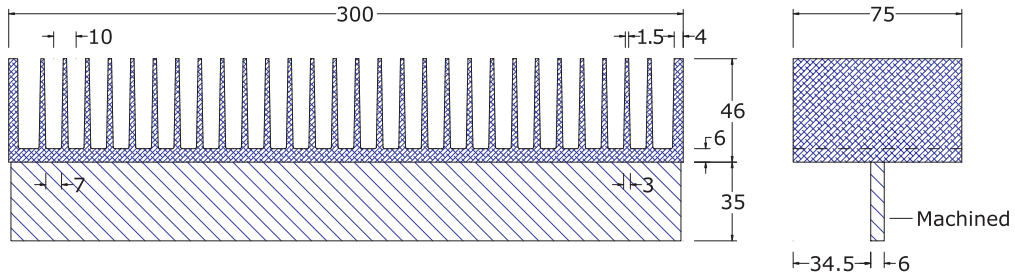

Product Code	Standard Lengths in mm	Thermal Resistance C/Watt for 80 C rise	Weight in kg.
MF30-1F-75	75.0	0.37	1.14

## ***MF15-2F-151.5***

All dimensions are in mm

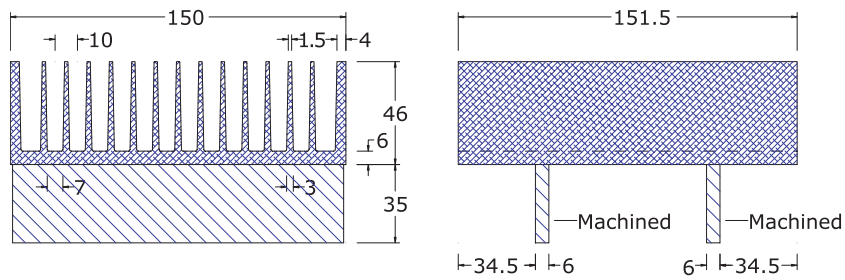

Product Code	Standard Lengths in mm	Thermal Resistance C/Watt for 80 C rise	Weight in kg.
MF15-2F-151.5	151.5	0.48	1.15

## ***MF20-2F-151.5***

All dimensions are in mm

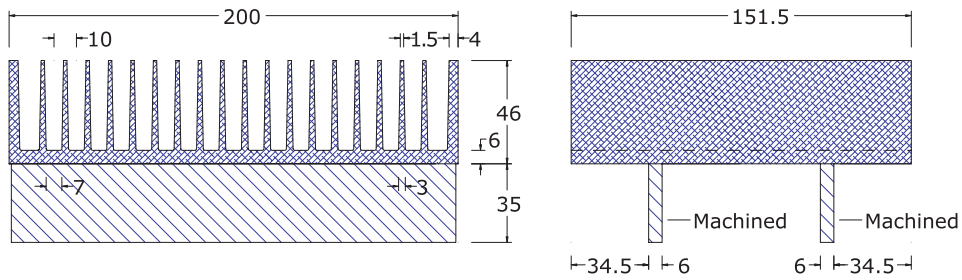

Product Code	Standard Lengths in mm	Thermal Resistance C/Watt for 80 C rise	Weight in kg.
MF20-2F-151.5	151.5	.038	1.51

## ***MF30-2F-151.5.***

All dimensions are in mm

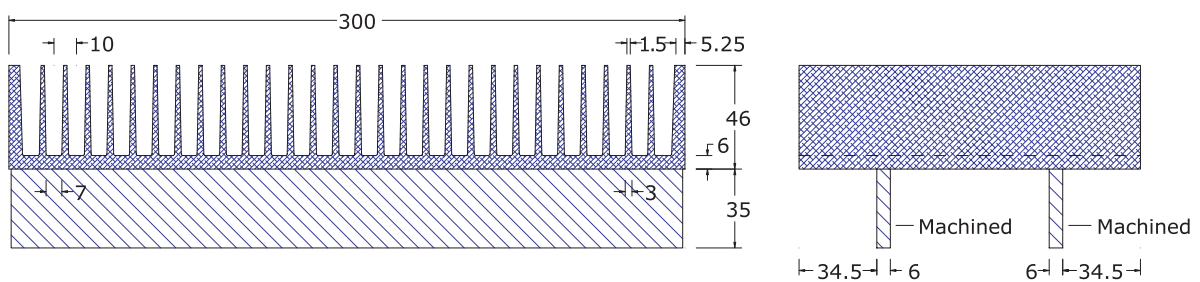

Product Code	Standard Lengths in mm	Thermal Resistance C/Watt for 80 C rise	Weight in kg.
MF30-2F-151.5	151.5	0.25	2.29

## 8FT Series

All dimensions are in mm.

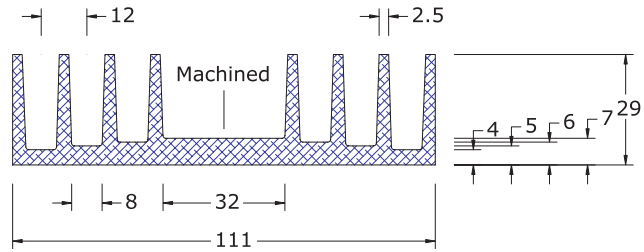

Product Code	Standard Lengths in mm	Thermal Resistance C/Watt for 80 C rise	Weight in kg.
8FT-50	50.0	2.32	0.16
8FT-75	75.0	1.78	0.25
8FT-100	100.0	1.40	0.33
8FT-151.5	151.5	1.00	0.50



## January 2005 Price List

Attractive freight rates available. For trade enquiries, please ask about our wholesale services.

Prices in Australian Dollars. (\$AUD) ex-GST

Exchange rates apply at the time of placing an order.

<i>Flat Backed Heatsinks</i>		<i>Weight kg.</i>	<i>Price \$AUD</i>
<b>MF 10</b>	-50	0.22	8.56
	-75	0.33	10.69
	-100	0.44	14.81
	-151.5	0.67	18.51
<b>MF 12</b>	-50	0.26	9.27
	-75	0.39	11.33
	-100	0.52	16.21
	-151.5	0.79	19.09
<b>MF 15</b>	-50	0.32	10.64
	-75	0.48	13.03
	-100	0.64	19.20
	-151.5	0.97	22.47
<b>MF 20</b>	-50	0.47	13.65
	-75	0.71	17.26
	-100	0.95	26.66
	-151.5	1.44	31.69
<b>MF 25</b>	-50	0.59	16.62
	-75	0.88	21.18
	-100	1.17	32.66
	-151.5	1.78	38.92
<b>MF 30</b>	-50	0.70	19.65
	-75	1.05	25.05
	-100	1.40	36.59
	-151.5	2.12	46.12
<b>MF 35</b>	-50	0.81	23.69
	-75	1.22	29.24
	-100	1.62	44.63
	-151.5	2.46	53.36
<b>MF 18</b>	-50	0.41	14.15
	-75	0.61	18.68
	100	0.82	28.57
	151.5	1.24	35.09
<i>Flanged Heatsinks</i>		<i>Weight kg.</i>	<i>Price \$AUD</i>
<b>MF 15-1F</b>	-75	0.57	16.64
<b>MF 20-1F</b>	-75	0.75	20.04
<b>MF30-1F</b>	-75	1.14	28.94
<b>MF 15-2F</b>	-151.5	1.15	30.94
<b>MF20-2F</b>	-151.5	1.51	36.85
<b>MF30-2F</b>	-151.5	2.29	52.05
<i>Single Channel Flat Backed Heatsinks</i>			
<b>8FT</b>	-50	0.16	5.72
	-75	0.25	7.10
	-100	0.33	9.80
	-151.5	0.50	12.84

Conrad Engineering reserves the right to alter any information contained in this catalogue without prior notification.



# Order Form

This order form is provided for customers who wish to post or fax an order.

## Conrad Heatsinks

Phone: 61 3 9387 7106  
Fax: 61 3 9387 2896  
sales@conradheatsinks.com

36 Victoria St  
East Brunswick 3057  
Victoria, Australia



Name: \_\_\_\_\_

Company name: \_\_\_\_\_

Fax: \_\_\_\_\_

Email: \_\_\_\_\_ @ \_\_\_\_\_

Delivery Address: \_\_\_\_\_

\_\_\_\_\_

City or District: \_\_\_\_\_

State: \_\_\_\_\_

Postcode or Zip: \_\_\_\_\_

Country: \_\_\_\_\_

Payment Method: \_\_\_\_\_

If faxing credit card details: ~

Card account name: \_\_\_\_\_

Card type: (Visa, Mastercard, Bankcard) \_\_\_\_\_

Card number: \_\_\_\_\_

Card expiry date: \_\_\_\_\_

For PayPal payments: sales@conradheatsinks.com account

EFT: Contact Conrad Heatsinks for banking details.



<i>Product type: (Code or Description)</i>	<i>Quantity</i>

Conrad Heatsinks will reply promptly with a confirmation quote and freight options and costs.